

THE

General Radio EXPERIMENTER



VOLUME XIX No. 6

NOVEMBER, 1944

ELECTRICAL MEASUREMENTS AND THEIR INDUSTRIAL APPLICATIONS

A 500-MC OSCILLATOR

Also IN THIS ISSUE

	Page
VARIACS FOR 400-CYCLE OPERATION	4
DISTRIBUTION OF STANDARD FREQUENCIES	6

● A NEW TYPE 857-A OSCILLATOR replaces the TYPE 757-A U-H-F Oscillator announced in August, 1941. Both oscillators use the same tube, but, while frequency range and power are very much the same, the circuits used are radically different. The new oscillator is only one-half the size and weight of the older type and should give much better performance in continued use, since all sliding contacts have been eliminated through the use of a butterfly circuit as the frequency determining element. This radically new type of tuned

FIGURE 1. View of the TYPE 857-A Oscillator with TYPE 857-P1 Power Supply.

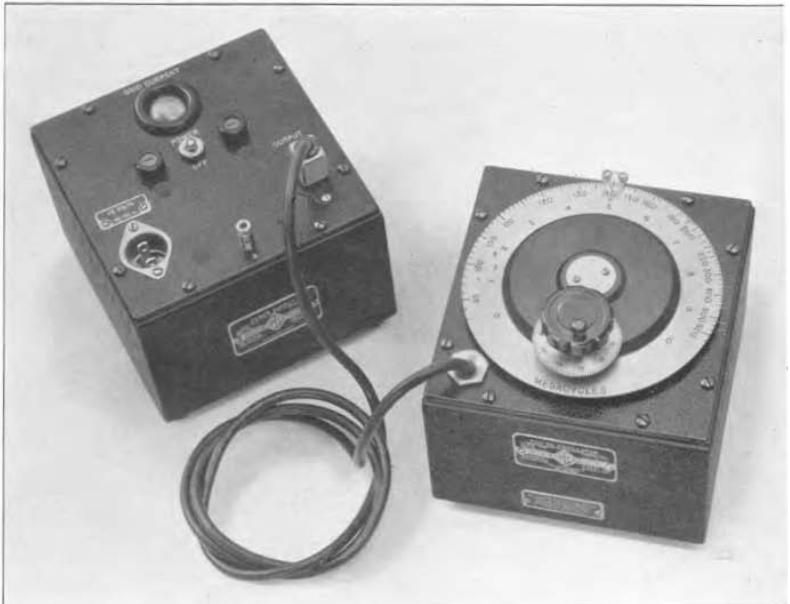

IET LABS, INC in the GenRad tradition

534 Main Street, Westbury, NY 11590

www.ietlabs.com

TEL: (516) 334-5959 • (800) 899-8438 • FAX: (516) 334-5988

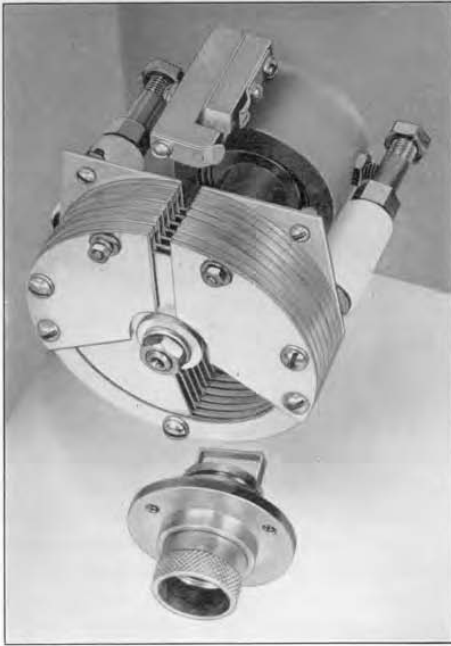

FIGURE 2. View of the tuned circuit of the TYPE 857-A Oscillator, showing also the output coupling loop and output jack in approximately their normal position.

circuit was discussed in detail in a previous issue of the *Experimenter*.*

The TYPE 857-A Oscillator together with the TYPE 857-P1 Power Supply are shown in Figure 1. The oscillator is intended for general laboratory use wherever a convenient source of radio-frequency power between 100 Mc and 500 Mc is required. The oscillator is contained in a metal housing that provides a moderate amount of shielding. Output is obtained at a coaxial jack at the side of the cabinet. Output coupling is inductive and can be varied continuously from maximum to practically zero.

The tuned circuit and its associated output coupling loop are shown in Figure 2.

For a 120° rotation of the rotor the effective capacitance of this circuit varies by a factor of 10.6 from 94 $\mu\mu\text{f}$ to 8.8 $\mu\mu\text{f}$, and the effective inductance by a factor of 2.9 from 30 cm to 10.3 cm, giving a frequency range of 95 Mc to 525 Mc. The capacitance variation of

*Eduard Karplus, "The Butterfly Circuit," *General Radio Experimenter*, XIX, 5, October, 1944.

Copyright, 1944, General Radio Company Cambridge, Mass., U. S. A.

FIGURE 3. Complete circuit diagram of the oscillator unit.

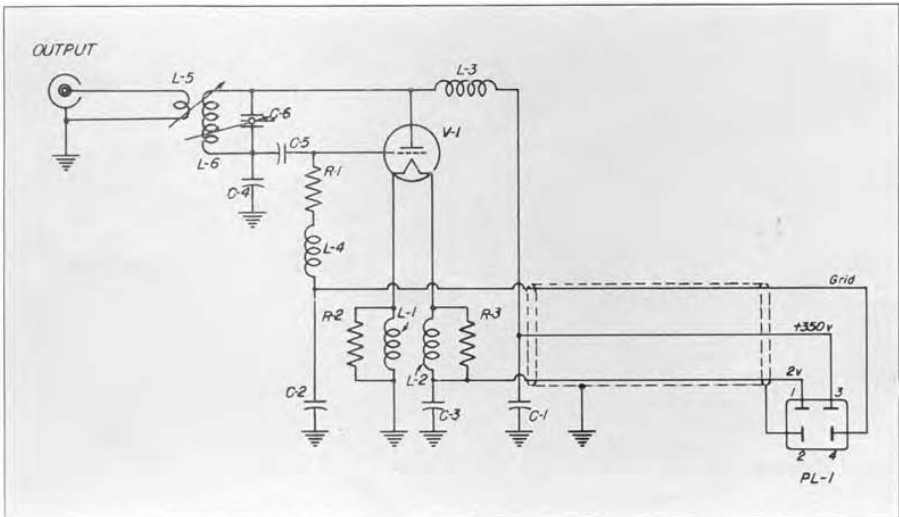



the tuning circuit alone is considerably better than these figures indicate since the grid-to-plate capacitance of the oscillator tube and a trimmer condenser are added to the minimum capacitance.

Grid and plate of the oscillator tube are connected directly across the tuned circuit as shown in Figure 3. The filament of the tube is fed by chokes, allowing it to assume a potential determined by the electrode capacitance of the tube and by the capacitance of the tuned circuit to ground. This latter capacitance is adjusted to optimum value by a small grounding condenser. To compensate for variations in tube-electrode capacitance, a trimmer condenser is provided.

The main dial is calibrated directly in megacycles. The vernier dial carries 100 uniform divisions and covers the tuning range in approximately 10 revolutions. An auxiliary scale on the main dial indicates revolutions of the vernier. A Western Electric TYPE 316-A Vacuum Tube is used in the oscillator. This tube has a thoriated tungsten filament, requiring 2 volts and 3.6 amperes. The maximum allowable plate voltage is 450 volts at 30 watts plate dissipation. Connections to the power supply are made through a

4-conductor shielded cable permanently attached to the oscillator.

The TYPE 857-P1 Power Supply is recommended as a power source. The plate voltage supplied is 350 volts, which is the highest voltage which can be used unless precautions are taken to prevent destruction of the oscillator tube if oscillations are stopped by overcoupling to the load. In addition to filament and plate supply circuits, the power supply contains an electron-ray tube connected to indicate the grid current of the oscillator. The eye of the indicator tube is closed in operation and opens when grid current is interrupted.

The maximum power output obtainable from the TYPE 857-A Oscillator is approximately 1 watt at 500 Mc and is greater at lower frequencies. When the TYPE 857-P1 Power Supply is used, the maximum power output is 0.5 watt.

Coupling to the load is varied by turning the shield of the output jack between two positions marked maximum and minimum, and further variation of the coupling is obtained by moving the output jack in and out through the metal housing. Three positions have been provided.

—EDUARD KARPLUS

TYPE 857-A OSCILLATOR SPECIFICATIONS

Frequency Range: 100 Mc to 500 Mc.

Frequency Calibration: The frequency dial is calibrated directly in megacycles with an accuracy of $\pm 1\%$.

Output Power: The oscillator can deliver a maximum of approximately 1 watt at the highest frequency. At lower frequencies the output power increases. If the oscillator is used with the TYPE 857-P1 Power Supply, the maximum power at the highest frequency is 0.5 watt.

Output Coupling: Output coupling can be varied from maximum to practically zero.

Dial and Drive: The main dial carries the fre-

quency scale and counts in addition the revolutions of the vernier dial. The gear reduction is 15:1 and, with 100 divisions on the vernier, approximately 1000 divisions are provided for the complete scale.

Vacuum Tubes: 1 Western Electric TYPE 316-A.

Accessories Supplied: 1 TYPE 775-M Cable Jack to fit the output connector of the oscillator.

Power Supply: Filament, 2.5 volts at 3.65 amperes. Plate, 450 volts maximum at 30 watts plate dissipation. The TYPE 857-P1 Power Supply has





been designed for this oscillator and its use is recommended. The plate power supplied by this unit is 350 volts at 50 milliamperes. The oscillator carries a permanently attached power cable which plugs into the power supply unit.

Mounting: The oscillator is mounted in a small metal cabinet.

Dimensions: $6\frac{7}{8} \times 7\frac{5}{8} \times 7\frac{1}{4}$ inches, over-all.

Net Weight: $6\frac{1}{4}$ pounds.

TYPE 857-P1 POWER SUPPLY

SPECIFICATIONS

Power Input: 115 or 230 volts, 42 to 60 cycles. Total power input, 50 watts with TYPE 857-A Oscillator connected.

Vacuum Tubes: 1 TYPE 543GT Rectifier and 1 TYPE 6E5 Electron-Ray Tube. Both are supplied.

Power Output: 2.5 volts AC at 3.65 amperes and 350 volts DC at 50 milliamperes.

Accessories Supplied: Spare fuses and 1 line connector cord.

Indicator: An electron-ray tube is mounted on the front panel to indicate grid current of the oscillator.

Dimensions: $5\frac{1}{2} \times 6\frac{5}{8} \times 6\frac{7}{8}$ inches, over-all.

Net Weight: $9\frac{1}{2}$ pounds.

Type		Code Word	Price
857-A	U-H-F Oscillator	OFTEN	\$250.00
857-P1	Power Supply	OFTENAPACK	
Patent Applied For			

VARIACS FOR 400-CYCLE OPERATION

● **EVER INCREASING DEMANDS** for voltage control devices at alternating-current frequencies of 400 cycles per second and higher have resulted in new additions to the Variac line. TYPES 60-AU (uncased) and 60-AM (cased) Variacs perform, at these higher fre-

quencies, the functions of the familiar TYPE 200-C Variac at 60 cycles. The nominal rating of 5 amperes, 0 to 135 volts when operating from a 115-volt line, may be increased to 7.5 amperes near the zero and line voltage regions.

Important features are:—

● Greatly decreased weight (60-AU, 3 lbs., 2 ozs. versus 200-CU, 8 lbs., 4 ozs.), accomplished by the use of a cast aluminum base, a hollow shaft, and a much smaller core made possible by the higher frequency and by the use of a "scroll" construction.

● General Radio's new Unit Brush, requiring no tools for brush change; and, in cooperation with a rigid radiator structure, preventing contact between brush holder and winding, a frequent cause of burnout in the past.



FIGURE 1. View of the TYPE 60-AM Variac showing terminal plate and dial.





- Combination solder and screw terminals for greater convenience in wiring.
- Elimination of the brush "pigtail."
- A single screw adjustment for shaft reversal when changing from panel to table mounting or vice versa.
- Fully insulated hollow steel shaft with no set screws bearing on bakelite.
- Bearing adequate for motor-driven applications. Like other Variacs, TYPES 60-AU and 60-AM are applicable to either adjustable load voltages or to line voltage regulation.

These new Variacs are not in quantity production. All of our Variac manufacturing facilities are fully occupied and scheduled far in advance on the production of the regular 60-cycle units. For the time being, therefore, the new 400-cycle Variacs can be manufactured in relatively very small quantities, which will be available as samples to those interested in determining their suitability for particular applications. The 60-cycle Variac has taken its place as a vital component in wartime equipment as it did

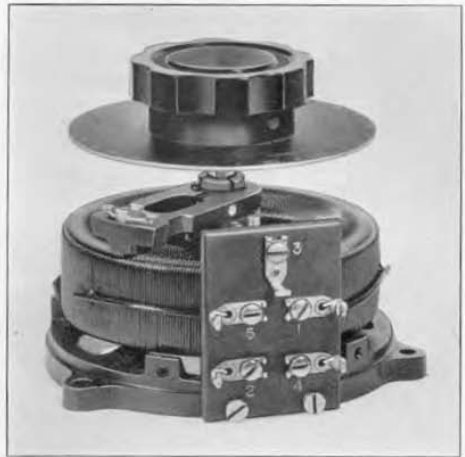
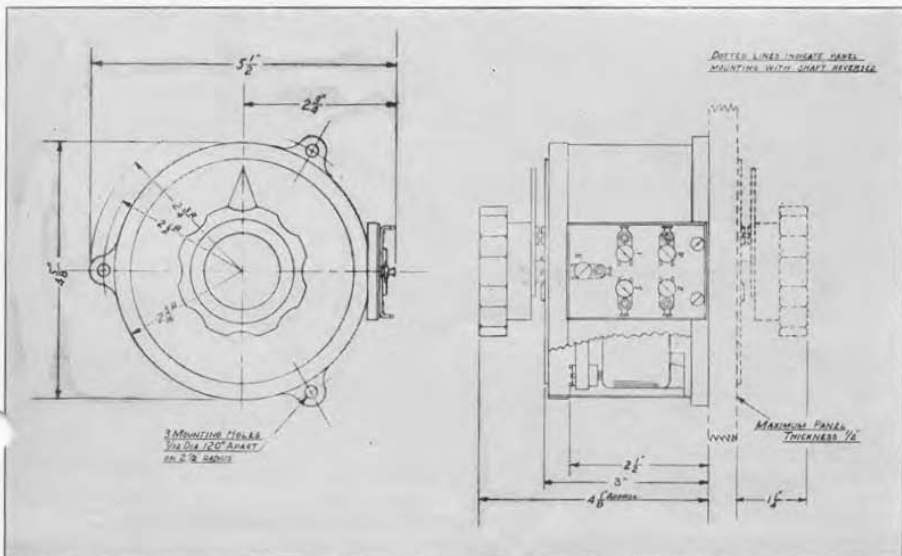

FIGURE 2. View of the uncased model, TYPE 60-AU, showing the new Unit Brush. The brush element is easily removed and replaced if necessary without the use of tools.

before the war in hundreds of civilian products. These top priority war applications are now, and have been since 1941, occupying all of our production facilities. When war requirements per-

FIGURE 3. Dimension sketch of the cased model with cutaway showing dimensions of uncased model.





mit, some machines can be converted for producing the new 400-cycle Variacs. In the meantime, the small preproduc-

tion run will be available soon after the first of the year.

— GILBERT SMILEY

SPECIFICATIONS

Load Rating: 860 va.

Input Voltage: 115 volts.

Frequency: 400 to 2600 cycles per second.

Output Voltage: 0 to 135 volts, or 0 to 115 volts.

Load Current: 5 amperes, rated; 7.5 amperes near zero and line voltages.

No-Load Loss: 7 watts at 400 cycles.

Dimensions: Over-all height for table mounting, 4 $\frac{1}{8}$ inches; depth behind panel for panel mounting, 3 inches; over-all diameter of base, 5 $\frac{1}{2}$ inches.

Net Weight: TYPE 60-AU, 3 pounds, 2 ounces. TYPE 60-AM, 3 $\frac{1}{2}$ pounds.

Type		Code Word	Price
60-AU	Variac (uncased model).....	BEGOT	\$13.00
60-AM	Variac (cased model).....	BEFOG	15.00

Variacs are manufactured and sold under U. S. Patent No. 2,609,013

DISTRIBUTION OF STANDARD FREQUENCIES

● **DEVELOPMENT** and manufacturing of electronic equipment require the availability of standard frequency facilities for testing and calibrating. If a large quantity of identical equipments is to be calibrated, a permanent arrangement of standard frequency facilities can be arranged for the purpose. However, if large quantities of equipments of a diversified nature are to be calibrated, a considerable degree of flexibility in the arrangement of standard frequency facilities is necessary.

The distribution arrangement described here is one which has served diversified requirements fairly well at the General Radio laboratories. At the central frequency standard a distribution amplifier is provided for supplying sine-wave outputs to the Engineering Department. Each of the output frequencies of 0.1, 1.0, 10.0, and 50.0 kc is filtered and connected to the inputs of four amplifiers in parallel. The outputs, at approximately 500 ohms impedance level, are individually available at jacks

FIGURE 1. Panel view of the distribution amplifier.

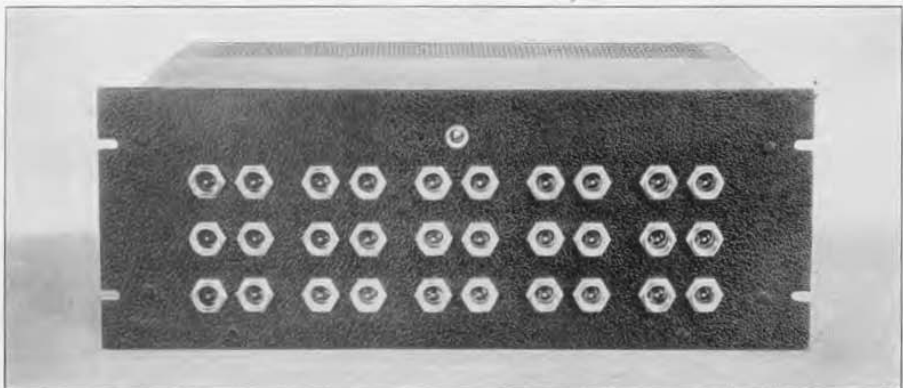



on the panel. Lines from the individual engineering laboratories terminate on jacks on a panel mounted below the amplifiers. By use of concentric patch cords, any line can be connected to any amplifier output.

The filtered output at each frequency is available at a pair of jacks on the distribution amplifier, where two "roving" amplifier inputs can be connected. Using these two amplifiers, a total of six channels can be made available on any one standard frequency, or five channels on any two.

Provision is also made, by two jacks in the upper right corner of the amplifier panel, for plugging in either, or both, "roving" amplifiers on the output of the TYPE 614 Selective Amplifier mounted in the standard frequency assembly. This selective amplifier provides output frequencies of any multiple of 1.0 kc from 1 to 10.

At the central frequency standard provision is made for 48 lines running to the individual engineering laboratories and to the manufacturing department.

Since the demand in the manufacturing department for standard frequencies includes both sine-wave and harmonic outputs, and since the number of operating positions is far larger than could be handled conveniently from the central standard, use is made of banks of multivibrators set up at various points in the department. These multivibrators are controlled by 50 kc from the central standard, so the output frequencies are identical with those available at the central location. At each multivibrator bank a distribution amplifier and line panel is provided for distributing the standard frequencies to workers near by.

In the crystal grinding department three similar banks of multivibrators are set up, with various frequency measuring



FIGURE 2. Top view of amplifier, with dust cover removed.

assemblies adjacent to them. The choice of multivibrators and units of the measuring equipment is made to meet the particular requirements of operations carried out at each location.

— J. K. CLAPP

PARTS LIST FOR THE DISTRIBUTION AMPLIFIER

(See circuit diagram on page 8)

RESISTORS

R-1 = 10 k Ω	R-12 = 10 k Ω	R-24 = 1.0 M Ω
R-2 = 10 k Ω	R-13 = 10 k Ω	R-25 = 20 k Ω
R-3 = 10 k Ω	R-14 = 10 k Ω	R-26 = 0.1 k Ω
R-4 = 10 k Ω	R-15 = 10 k Ω	R-27
R-5 = 10 k Ω	R-16 = 10 k Ω	to
R-6 = 10 k Ω	R-17 = 10 k Ω	to
R-7 = 10 k Ω	R-18 = 10 k Ω	R-44
R-8 = 10 k Ω	R-19 = 1.0 M Ω	R-45
R-9 = 10 k Ω	R-20 = 1.0 M Ω	R-46
R-10 = 10 k Ω	R-21 = 1.0 M Ω	R-47 = 1 k Ω
R-11 = 10 k Ω	R-22 = 1.0 M Ω	R-48
	R-23 = 1.0 M Ω	R-49

FIGURE 3. View from below with dust cover removed, showing arrangement of resistors and capacitors.

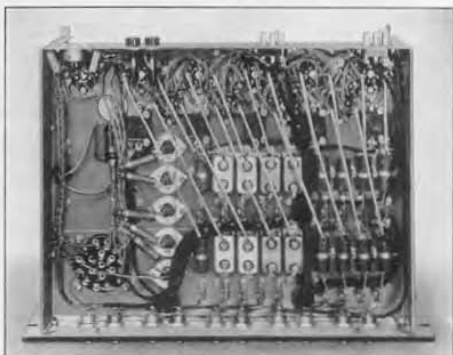

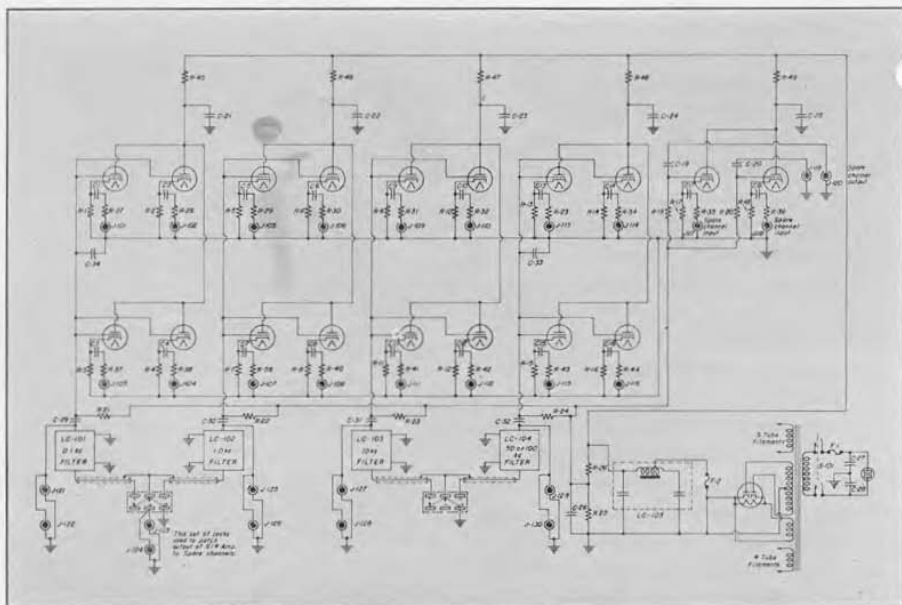

FIGURE 4. Complete circuit diagram of the distribution amplifier.

CONDENSERS

- | | | | |
|-------------------|--------------------|---------------------|-----------------------|
| C-1 = 16 μ f | C-10 = 0.5 μ f | C-18 = 16 μ f | C-26 = 16 μ f |
| C-2 = 16 μ f | C-11 = 0.5 μ f | C-19 = 0.03 μ f | C-27 = 0.01 μ f |
| C-3 = 16 μ f | C-12 = 0.5 μ f | C-20 = 0.03 μ f | C-28 = 0.01 μ f |
| C-4 = 16 μ f | C-13 = 0.1 μ f | C-21 = 20 μ f | C-29 = 0.03 μ f |
| C-5 = 16 μ f | C-14 = 0.1 μ f | C-22 = 20 μ f | C-30 = 0.03 μ f |
| C-6 = 16 μ f | C-15 = 0.1 μ f | C-23 = 20 μ f | C-31 = 0.03 μ f |
| C-7 = 16 μ f | C-16 = 0.1 μ f | C-24 = 20 μ f | C-32 = 0.03 μ f |
| C-8 = 16 μ f | C-17 = 16 μ f | C-25 = 20 μ f | C-33 = 0.0001 μ f |
| C-9 = 0.5 μ f | | | C-34 = 0.0001 μ f |

J-101 }
to } = G.R. TYPE 774-G
J-130 }

- LC-105 Rectifier Filter
- LC-101 to LC-104 Low-Pass Filters
- T-101 Power Transformer
- F-1 = 2.0 amp.
- F-2 = 0.2 amp.

Note: This amplifier was built for use in the General Radio laboratories and is not for sale as a standard catalog instrument. Owing to the pressure of essential war production the General Radio Company cannot furnish either complete amplifiers of this type or parts from which they can be constructed. This description is published merely as a guide to those who may wish to build similar equipment using such parts as are generally available. — EDITOR.

THE General Radio EXPERIMENTER is mailed without charge each month to engineers, scientists, technicians, and others interested in communication-frequency measurement and control problems. When sending requests for subscriptions and address-change notices, please supply the following information: name, company name, company address, type of business company is engaged in, and title of position of individual.

GENERAL RADIO COMPANY
 275 MASS. AVE. - CAMBRIDGE 39, MASSACHUSETTS
 BRANCH ENGINEERING OFFICES
 90 WEST STREET, NEW YORK CITY 6
 920 SOUTH MICHIGAN AVENUE, CHICAGO 5, ILLINOIS
 1000 NORTH SEWARD STREET, LOS ANGELES 38, CALIFORNIA

